

Waterproof 5 in 1 LED Controller (WiFi + 2.4G) Instruction Manual

Contents

<u>Product features</u>	2
<u>Set up output mode</u>	3
<u>Compatible with remote</u>	3
<u>2.4G RF remote control instruction</u>	4-7
<u>Link / Unlink Instructions</u>	4
<u>Auto transmitting & Synchronization</u>	5
<u>Dynamic mode table selection</u>	5-6
<u>PWM frequency switching</u>	6
<u>“Do Not Disturb” mode is activated and shut down</u>	7
<u>Smartphone app control instruction</u>	7-8
<u>Alexa voice control instruction</u>	9
<u>Google home voice control instruction</u>	10
<u>DMX512 LED transmitter control instruction</u>	11
<u>Connect to LED strip diagram</u>	12
<u>Attention</u>	13

Product features

This product uses WiFi + Bluetooth + 2.4G wireless transmission technology, low power consumption, strong anti-interference ability. WiFi + Bluetooth connect network can greatly enhance the connect network experience. When the router is disconnected, Bluetooth can also directly connect and control equipment at close range.

After successful network configuration using **[Tuya Smart]** app to achieve wireless dimming, remote control, group control, scene control, timing control, music movement, biorhythm, sleep plan, wake plan, one key execution, automation, etc. functions. And it supports 2.4G remote control.



16 Millions of colors to choose



Color temperature adjustable



Dim brightness / Saturation



2.4G RF wireless transmission technology



WiFi wireless control support long-range control



Auto-transmitting & Synchronization (only for remote control dimming)



Device sharing



Tap-to-Run & automation



Timing setting / countdown turn on / off LED light



DMX512 controllable (Only for RGB+CCT output mode DMX512 LED transmitter is needed)



Remote control Control distance 30m



Smartphone app control



Support third party voice control



Group contro



Biorhythm



Support music rhythm



Sleep / wake up plan



Support scene customization



Do not disturb mode



Waterproof and dustproof grade IP67

Set up output mode

Set up correct output mode based on the feature of lights

Setting method: Press "SET" button continuously to switch output mode (attention: it will log out without operation within 3 seconds)

Output mode sheet (confirm output mode based on color of indicator)

Indicator color	White Light	Yellow Light	Red Light	Green Light	Blue Light
Output	Single Color	Dual White	RGB	RGBW	RGB+CCT

Compatible with these 2.4G RF remote controls (Purchased separately)



FUT100



FUT089S



FUT089
FUT089-B

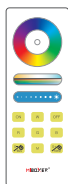

FUT088



FUT092
FUT092-B



FUT096
FUT096-B



B8



B0 / B0-B



B4 / B4-B / T4



B3 / B3-B / T3



S2-B / S2-W
S2-G

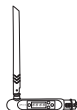

FUTD01

2.4G RF Remote control instruction

1). Linking Code Instructions

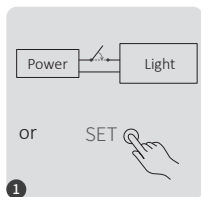

Power off 10 seconds and power on again or short press "SET" one time



Short press "I" button 3 times within 3 seconds.

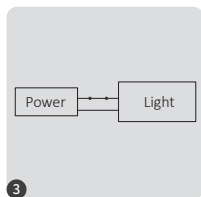

Lights blink 3 times slowly means linking is done successfully.



Linking failed if light is not blinking slowly, Please follow above steps again. (Note: Light that have linked can't link again)

2). Unlinking Code Instructions

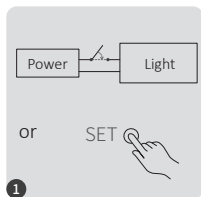

Power off 10 seconds and power on again or short press "SET" one time



Short press "I" button 5 times within 3 seconds.

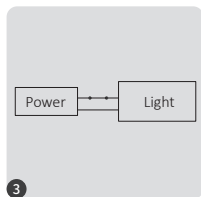

Lights blink 10 times quickly means unlinking is done successfully.



Unlinking failed if light is not blinking quickly, Please follow above steps again. (Note: Light haven't linked that don't need to unlink)

3). Auto transmitting & Synchronization (only for remote control)

Remote signal auto transmitting

One light can transmit the signals from the remote control to another light within 30m, as long as there is a light within 30m, the remote control distance can be limitless.

Dynamic modes auto synchronization

Multi lights can synchronize if they are in same dynamic mode and linked with same remote (distance between each light is within 30m)

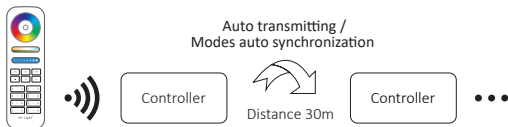

4). Dynamic mode table selection (only for remote control)

Select dynamic mode table 1:

While the light is in static mode, short press “S+” button 5 times quickly until blue light flashes 3 times slowly, static mode is activated successfully.

Select dynamic mode table 2:

While the light is in static mode, short press “S-” button 5 times quickly until yellow light flashes 3 times slowly, static mode is activated successfully.

Dynamic mode table 1 (default)

Number	Dynamic Mode	Brightness / Saturation / Speed
1	Mardi Gras	Adjustable
2	Automatic color change	
3	Sam	
4	Gemstone	
5	Twilight	
6	American	
7	Fat Tuesday	
8	Party	
9	Slow Color Splash	

Dynamic mode table 2 (need to switch manually)

Number	Dynamic Mode	Brightness / Saturation / Speed
1	Seven colors gradual change	Adjustable
2	White light Gradual change	
3	RGB gradual change	
4	Seven colors jump to change	
5	Jump to change randomly	
6	Red light gradual change +Flash 3 times	
7	Green light gradual change +Flash 3 times	
8	Blue light gradual change +Flash 3 times	
9	White light gradual change +Flash 3 times	

5). PWM high frequency / low frequency switching (only for remote control)

Switch to high frequency (16KHz):

Press "OFF" button 1 time within three seconds and press "ON" button 5 times, Activated successfully once led light flashes 2 times quickly.

Switch to low frequency (250Hz):

Press "ON" button 1 time within three seconds and press "OFF" button 5 times, Activated successfully once led light flashes 2 times slowly.

6). "Do Not Disturb" mode is activated and shut down (default activated)

Turn on "Do Not Disturb" mode (wide using in the area which have power failure frequently to save energy)

2.4G RF Remote turn on and turn off instruction

Turn on "Do Not Disturb" mode:

Press "OFF" button three times within three seconds and press "ON" button three times, Activated successfully once led light flashes four times quickly.

Attention: Do not disturb mode is activated

1. When the light is OFF status (For example: Use app or remote to turn off light)
The light is OFF status once you turn off power and turn on again.

(User must turn off and turn on power twice times to activate light or use APP / remote to activate light)

2. When the light is ON status
The light is ON status once you turn off and turn on power one time.

Turn off "Do Not Disturb" mode:

Press "ON" button three times within three seconds and press "OFF" button three times, closed successfully once led light flashes four times slowly.

Attention: The light will be always "ON" status if you turn on and turn off power once user closed "Do Not Disturb" mode.

App turn on and off "Do Not Disturb" mode instruction ([check details in page 8](#))

Smartphone APP control instruction

Network Configuration (Don't support 5G router)

1. Download and install [Tuya Smart] app

Search for [Tuya Smart] in Apple or Google store or scan following QR code to download and install the app.
Please open the app click " Register " button to create account while using it in the first time,
Log in directly if you already had account.



2. Network Configuration

- (1) Connect controller with power supply.
- (2) Confirm indicator light is flashing quickly (2 flashes per second),
If indicator light isn't in fast flashing state, there are two ways to enter:
 - Long press " SET " key until indicator light flashing quickly.
 - Power off and on controller 3 times.
- (3) Connect phone with home WiFi network in the 2.4GHz frequency.
- (4) Open homepage of app and click " + " button at the upper right corner of page.
- (5) Click " Lighting " on the left side of page and then click " Light Source (BLE+Wi-Fi) "
- (6) Follow app prompts to complete configuration.

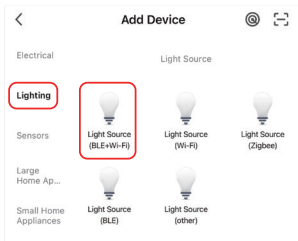
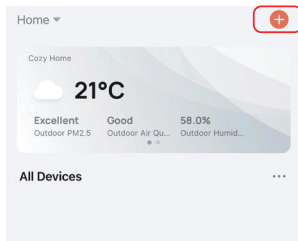

App turn on and off "Do Not Disturb" mode (default activated)

Click the light which need to be set up or group control --- click "More" --- click "Power-on behavior" --- turn on or off

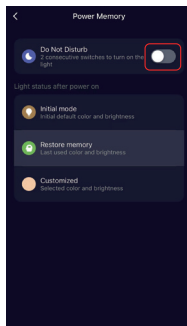
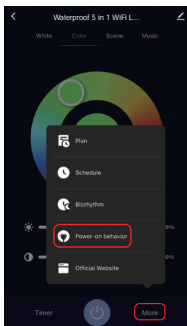
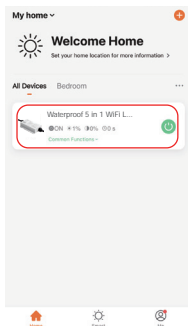

Alexa voice control instruction

Please add device into **[Tuya Smart]** app ([check details in page 7](#)), then start following steps

- 1). Open Alexa App
- 2). Click “More” on the bottom of right corner
- 3). Click “Skills & Games”

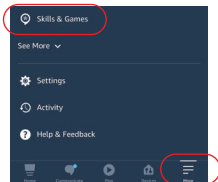

- 4). Click “Q” on the top of right corner
- 5). Type into “Smart life” and search



- 6). Click “Smart Life” skill, follow instruction to finish configuration and start voice control

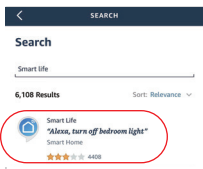

Google Home voice control instruction

Please add device into **[Tuya Smart]** app (check details in page 7), then start following steps

- 1). Open Google Home App
- 2). Click “+” on the top of left corner

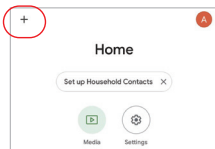

- 3). Click “Set up device”

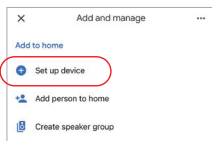

- 4). Click “Works with Google”

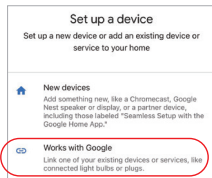

- 5). Click “Q” on the top of right corner
- 6). Type into “Smart life” and search
- 7). Click “Smart Life” skill, follow instruction to finish configuration and start voice control

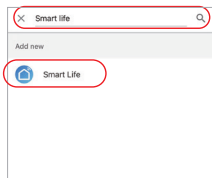

DMX512 LED Transmitter Control (Purchased separately)

Only for RGB+CCT output mode

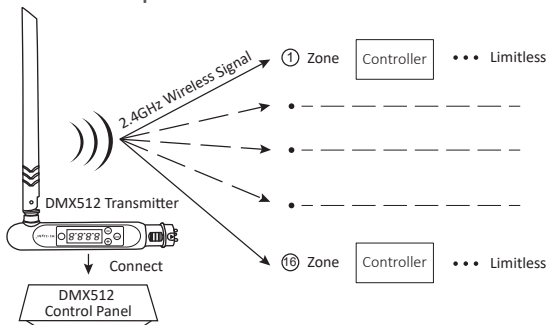

DMX512 LED Transmitter Link/Unlink

- 1 Follow instruction of DMX512 transmitter (FUTD01), Choose the zone for the light by pressing “+” or “-” (e.g. “CH12” means zone 12)

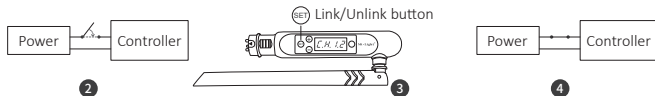

Link

The controller is powered off for 10 seconds and then powered on, or press “SET” button 1 time.

Short press “**SET**” 3 times within 3 seconds while the indicator of controller is ON

Link is done once indicator of controller flashes 3 times slowly

Unlink

The controller is powered off for 10 seconds and then powered on, or press “SET” button 1 time.

Short press “**SET**” 5 times within 3 seconds while the indicator of controller is ON

Unlink is done once indicator of controller flashes 10 times quickly



If the link or unlink failed, please follow the above steps again.

Connect to LED strip diagram



Controller input voltage must be in accordance with the required voltage of LED Strips.

Single Color

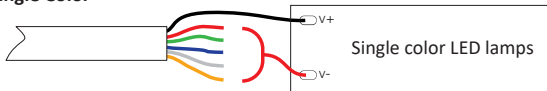

Dual White

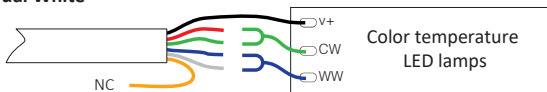

RGB

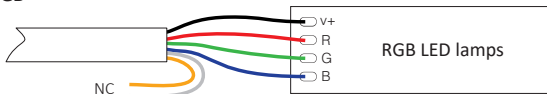

RGBW

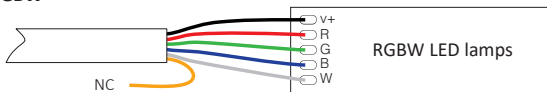

RGB+CCT

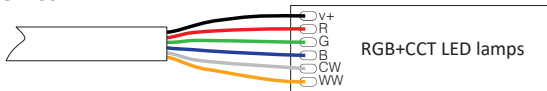

Instruction

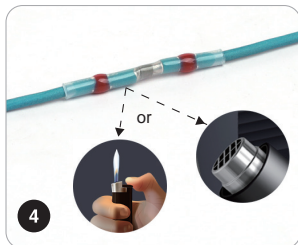
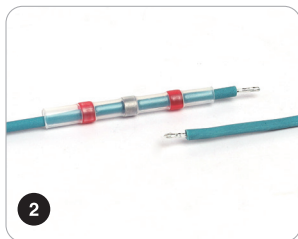

Attention

1. Please turn off power supply before installation.
2. Please ensure input voltage to be same as requirements from device.
3. Don't disassemble device if you are not expert, otherwise it will damage it.
4. Please do not use the light in the place with widely range metal area or strong electromagnetic wave nearby, otherwise, the remote distance will be seriously affected.



Made in China