

## 9W deep anti-glare LED CCT downlight

Model No.: FUT076

### Product Feature

- Deep plastic enclosure with best anti-glare performance, UGR≤19
- Dimmable color temperature from 2700-6500K
- 2.4G wireless transmission technology
- smooth dimming with 4096 level, mini brightness 0.1%
- Signal auto transmitting extend distance of communication
- Have DND function, usually used in power failure area and save power
- Support TUYA SMART app control (2.4G gateway is needed)
- Support third party voice control like Alexa, Google assistant, Yandex Alice, Tmall Genie, Baidu and Xiaomi



### Product Parameter

Product Name: 9W deep anti-glare LED CCT downlight	IP rate: IP20
Model No.: FUT076	Working Temperature: -10~40°C
Input voltage: AC100~240V 50/60Hz	Hole Size: 60mm
Power: 9W	Dimming Level: 4096
Power factor: >0.5	Dimming Range: 0.1-100%
CRI: >90	Dimming Curve: logarithm
Color temperature: 2700~6500K	EMC Standard (EMC): ETSI EN 301 489-1 V2.2.3 ETSI EN 301 489-3 V2.3.2
Luminous Flux: 700LM	Security Standard (LVD): ET IEC 60598-1:2021+A11:2022 EN 60598-2-2: 2012 EN IEC 62031:2020+A11:2021 EN 62498:2015+A1:2022
Luminous efficiency: 78LM/W	Radio equipment (RED): ETSI EN 300 440 V2.2.1
Beam Angle: 24°	Certification CE, EMC, LVD, RED
Protocol: 2.4GHz RF	
Control Distance: 30M	

### Dimension

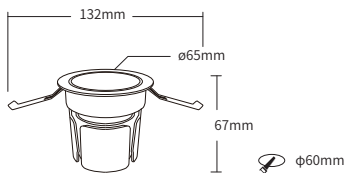

## Installation Tips

Please read instruction before installing it, you can contact with our service center if there is any technical issue

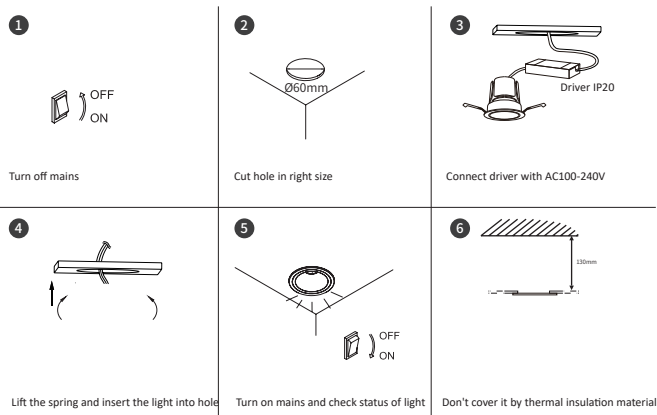

Lighting source can not be replaced, please buy new light if the light is over lifetime

## Auto transmitting

### signal auto transmitting

The light receive signal from remote and auto transmitting to another lights within 30m, it can extend unlimited distance

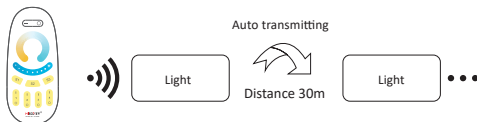

# Link/Unlink

**Link** controller must link with remote before using it

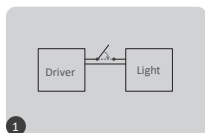

turn off light 10 seconds and turn on again

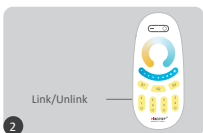

short press "ON" 3 times within 3 seconds

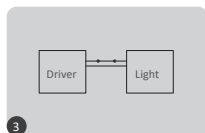

link is done once light flashes 3 times slowly



Link is failed if light doesn't flash, please repeat above steps (Attention: can not link again if remote already finished linking)

**Unlink:**

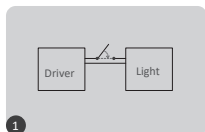

turn off light 10 seconds and turn on again

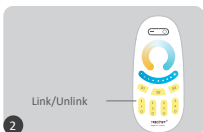

short press "ON" 5 times within 3 seconds

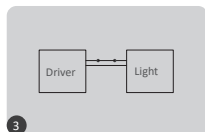

link is done once light flashes 10 times quickly



Unlink is failed if light doesn't flash, please repeat above steps (Attention: no need to unlink if the light never be linked)

## Compatible Remote ( purchase separately)



FUT094



FUT006



FUT007



FUT087/ FUT087-B



B1/ B1-B/ T1



B2/ T2



K1/ K1-B



K2/ K2-B



K3



C1



C3



Y2

DND mode ON/OFF ( factory default is ON)

### Turn ON DND:

Short press "OFF" 3 times within 3 seconds and short press "ON" 3 times, DND mode is activated if the light flashes 4 times quickly

**Attention:** The status of light ( ON or OFF) is same as turn on or off mains

### Turn off DND

Short press "ON" 3 times within 3 seconds and short press "OFF" 3 times, DND mode is shut down if the light flashes 4 times slowly

**Attention:** The light is always ON if turn on or off mains

## Connection Diagram

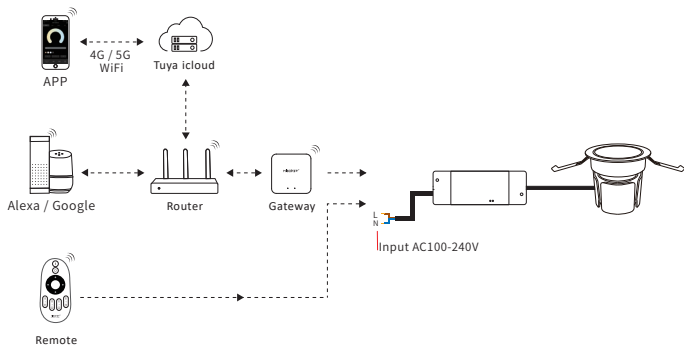

## Attention

- 1.Please ensure that voltage, N and L are correct connection, it will damage the light with wrong wiring
- 2.Please turn off mains before wiring cable and ensure that connection don't have any problem like short circuit
- 3.Don't disassemble it if you are not expert
- 4.Don't use it near magnetic or metal area, it will affect signal and reduce distance.



Made in China